

HLS12-5050, HLS12-50210, HLS12-50380

#1-02456, #1-02457, #1-02458

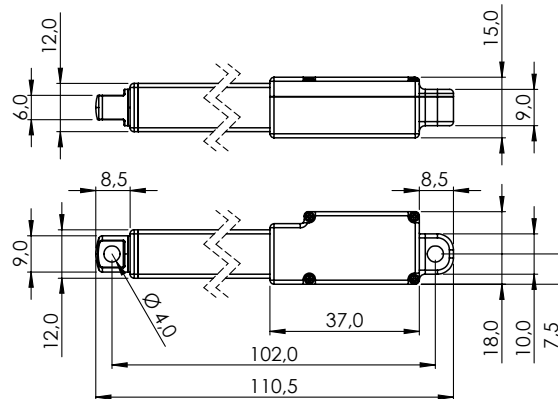

General Specification				HLS12-50XXX					
Control System	Pulse Width Modulation (PWM)			1000usec ~ 2000usec					
Position Sensor Type	-								
Operating Voltage Range	4.8 ~ 7.4V								
Motor Type	Cored Metal Brush								
Controller (MCU)	32Bits Programmable Digital								
Lead Screw	Lead 5mm								
Stroke Option	50mm								
Repeatability	±0.3mm								
Gear Ratio	50:1			210:1			380:1		
Voltage	At 7.4V			At 7.4V			At 7.4V		
No Load Speed	30.9mm/s			7.5mm/s			4.1mm/s		
No Load Running Current	130mA			130mA			130mA		
Load Spec	Load	Speed	Current	Load	Speed	Current	Load	Speed	Current
Maximum Efficiency Point	1.2kg (12.1N)	23.5mm/s	250mA	4.4kg (43.6N)	5.6mm/s	250mA	8.0kg (78.7N)	3.1mm/s	250mA
Peak Power Point	2.1kg (20.6N)	17.3mm/s	370mA	7.7kg (75.1N)	4.0mm/s	370mA	12.4kg (121.1N)	2.3mm/s	370mA
Max Force (Lifted)	2.7kg (26.6N)	8.2mm/s	490mA	9.9kg (96.9N)	2.8mm/s	490mA	14.8kg (145.3N)	1.5mm/s	490mA
Stall Torque	3.1kg (30.3N)			12.4kg (121.1N)			22.2kg (218.0N)		
Stall Current	620mA								
Max Static Force	247N (above)								
Max Side Load (Extended)	30N								
Operating Temperature Range	-10°C ~ +50°C (14°F ~ +122°F)								
Storage Temperature Range	-30°C ~ +80°C (-31°F ~ +176°F)								
Vibrations at No Load	-								
Connector Wire Length	160mm								
Connector Wire Gauge	-								
Outline Dimensions	102.0 x 15.0 x 18.0mm								
Weight	40.0g								
Ball Bearing	Flange Bearing								
Case Material	Engineering Plastic & Aluminum Pipe								
Gear Material	4 Metal Gears								
Dust & Water Protection class	IP4X								
Revision	Rev. 1.0 / 16.03.2022								
Changelog	-								

*of the servo only w/o horns and accessories